



**BUROSERV**

QUICK START GUIDE

22 January 2020

# DECT Conference Phone

CP930W-Base & CP930W

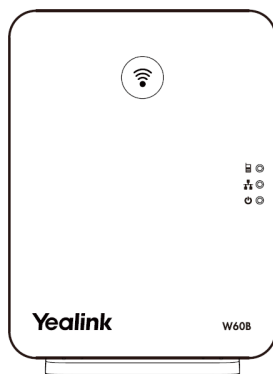

**Yealink**

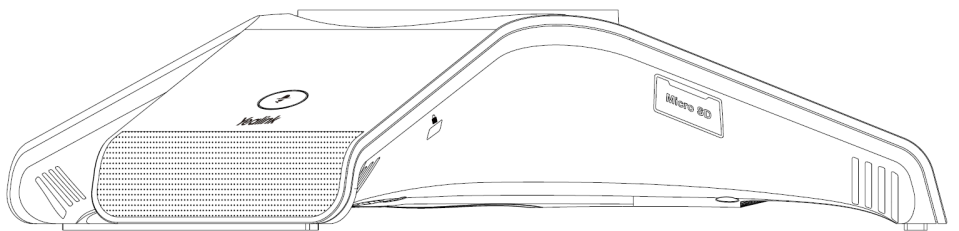

For W60B firmware: 77.83.0.20 or later  
For CP930W firmware: 87.83.0.20 or later

Developed by: **BUROSERV Australia**  
Level 2, 9 Help Street Chatswood NSW 2067. Australia

Version 1.0

# Contents

CP930W-Base Package Contents .....	3
CP930W Package Contents .....	3
Assembling the DECT Phone .....	4
Getting Started .....	6
Hardware Overview .....	6
Registration .....	6
Network Settings .....	7
Basic Operations .....	7
Turning CP930W On/Off .....	7
Handset Settings .....	7
Handset Name .....	7
Volume Adjustment .....	8
Ring Tones .....	8
Local Directory .....	8
Basic Call Features .....	8
Placing Calls .....	8
Answering Calls .....	9
Ending Calls .....	9
Call Mute and Unmute .....	9
Call Hold and Resume .....	9
Local Conference .....	9
Call Recording .....	10
Call Transfer .....	10
Call Forward .....	11

## CP930W-BASE PACKAGE CONTENTS



CP930W



W60B Base Station



Base Stand

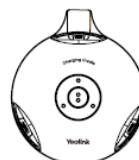

Charging Cradle



2 Power Adapters



CP930W-Base & CP930W  
Quick Start Guide



Ethernet Cable

Note: Yealink CP930W-Base DECT conference phone consists of one W60B base station and one CP930W.

## CP930W PACKAGE CONTENTS

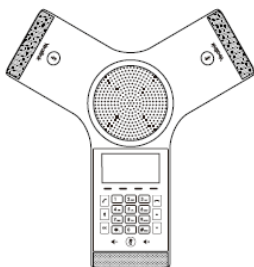

CP930W



Charging Cradle



Power Adapter



CP930W-Base & CP930W  
Quick Start Guide

## ASSEMBLING THE DECT PHONE

### 1. Connect the base station power and the network using method a or method b.

#### a. AC Power Option

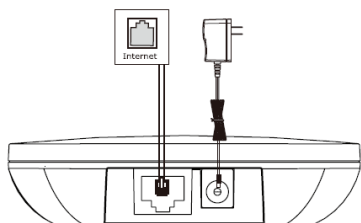

#### b. PoE (Power Over Ethernet) Option

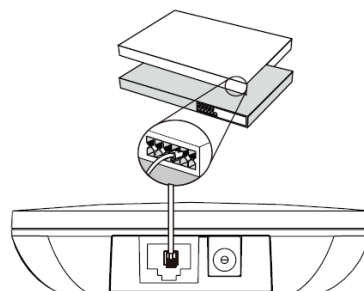

#### Note:

- If you choose method a, use Yealink-supplied power adapter (5V/600mA). A third-party power adapter may damage the base station.
- If you choose method b, you do not need to connect the power adapter. Make sure the hub/switch is PoE-compliant.

### 2.A (Desktop Installation) Attach and remove the base stand.

#### Attach the Base Stand

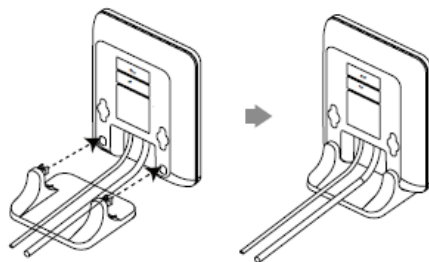

Align the snap-fits with the corresponding holes and push forward, snapping them into the holes.

#### Remove the Base Stand

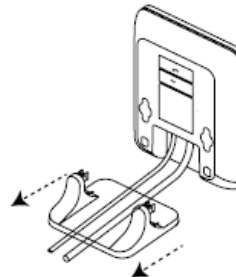

Remove the snap-fits from the holes horizontally.

### 2.B (Wall-Mount Installation) Attach the base station.

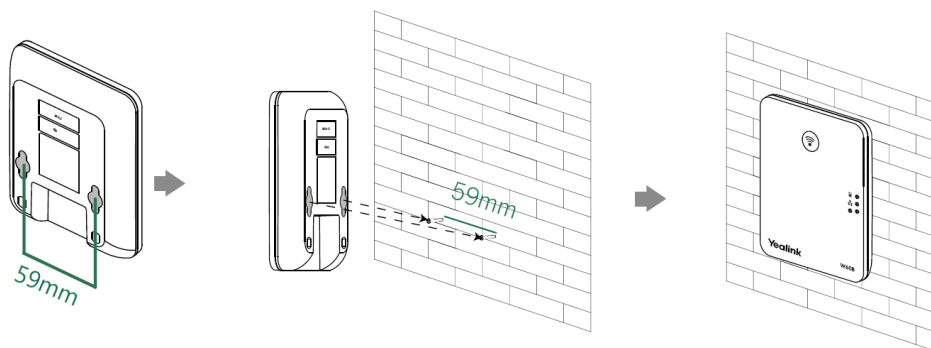

### 3. Connect the charging cradle and charge the CP930W.

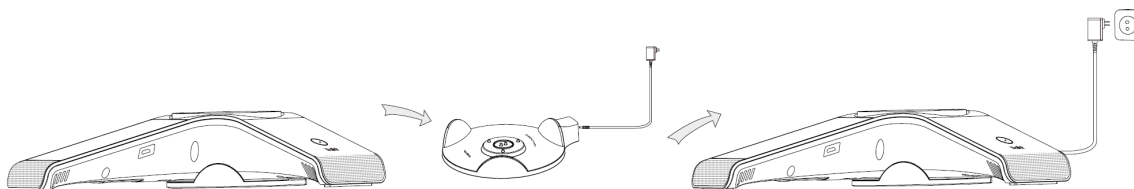

#### Note:

- Use Yealink-supplied power adapter (12V/1A). A third-party power adapter may damage the DECT conference phone.
- Check the charging status on the top-right corner of the LCD screen.

### 4. Connect the optional PC.

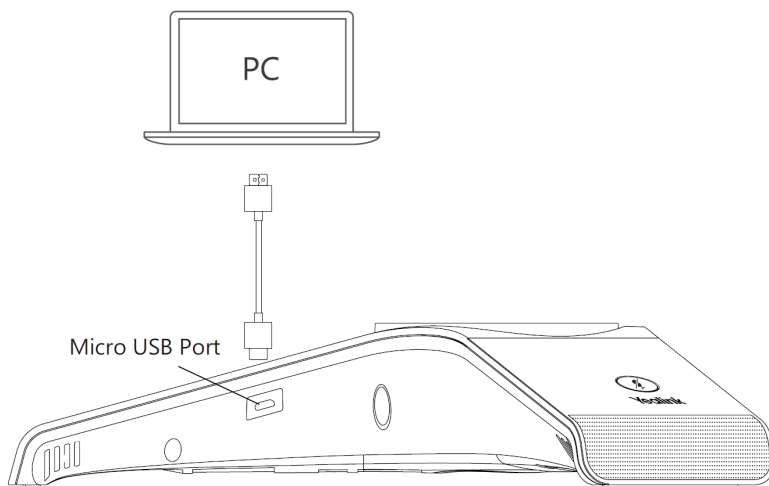

### 5. Connect the optional SD card.

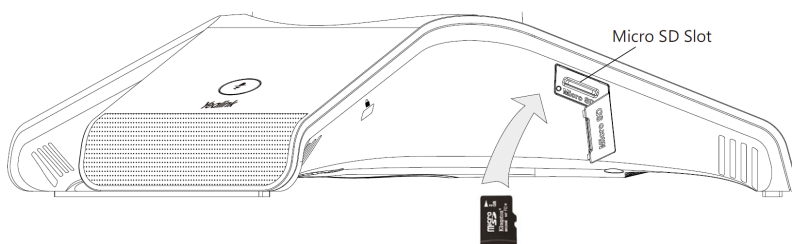

## GETTING STARTED

### HARDWARE OVERVIEW

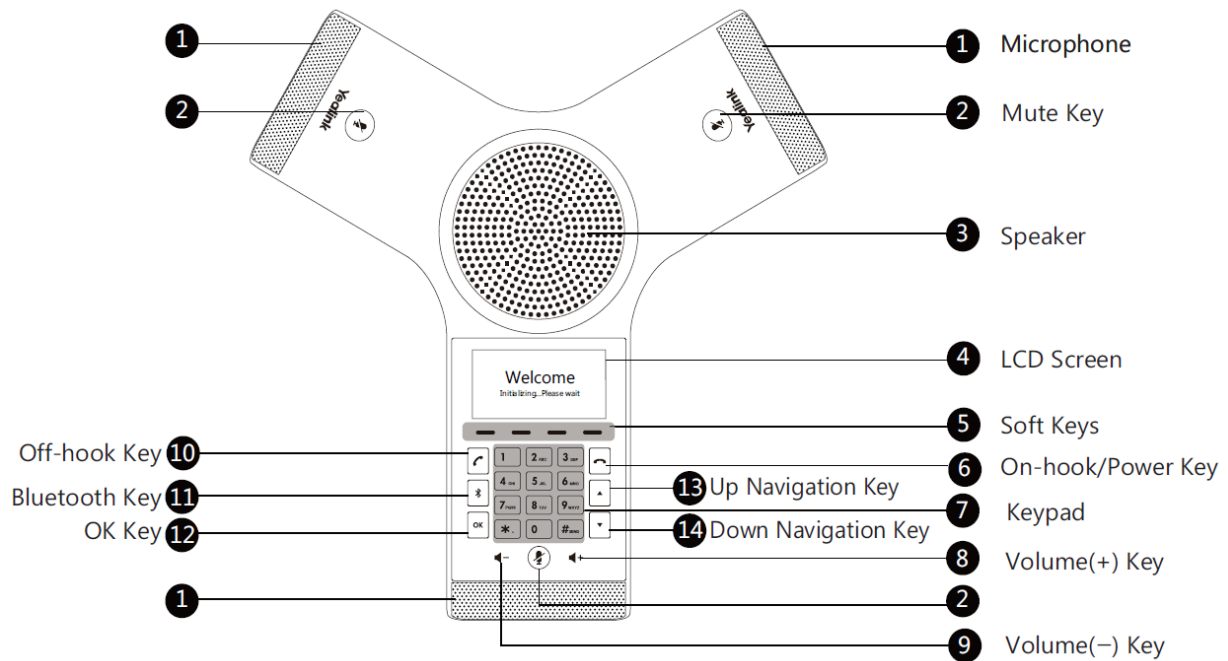

### REGISTRATION

You can register up to 8 CP930W to one W60B base station. Each CP930W can only be registered up to one base station.

When the CP930W LCD screen prompts “Unregistered!”, long press  on the base station till the registration LED indicator flashes.

There are two methods to register a new CP930W:

#### Easy Registration:

1. Tap the **Reg** soft key on the CP930W to register quickly.

#### Normal Registration:

1. Tap the **OK** soft key on the CP930W, and then select **Register Handset**.
2. Select the desired base station and then tap the **OK** soft key.

The CP930W begins searching the base station.

3. Tap the **OK** soft key after searching a base station successfully.
4. Enter the base station PIN (default: 0000), and then tap the **Done** soft key to complete the registration.

To register to multiple base stations, tap the **Menu->Settings->Registration->Register Handset**, then repeat steps 2-4.

#### Note:

- If the CP930W is registered to the base station successfully, the LCD screen prompts “Handset Subscribed” and “Base NO.” (the “NO.” indicates the last 4 characters of the base station’s MAC address).
- If the CP930W LCD screen prompts “Searching for Base”, check that your base station is powered on.

## NETWORK SETTINGS

You can configure the base station to obtain network settings in one of the following ways:

### DHCP

By default, the base station attempts to contact a DHCP server in your network to obtain the valid network settings, such as IP address, subnet mask, gateway address and DNS address.

### Static

If the base station cannot contact a DHCP server for any reason, you need to configure the IP address, subnet mask, gateway address, primary DNS address and secondary DNS address for the base station manually.

#### To configure the network parameters for the base station manually:

1. Tap **Menu->Settings->Advanced Settings (default PIN: 0000)->Network->Basic**.
2. Select the desired IP addressing mode from the **IP Mode** field.
3. Select the desired IP addressing mode.
4. Make the desired changes.
5. Tap the **Save** soft key to accept the change.

#### Note:

- The DECT conference phone supports either or both IPv4 and IPv6 addressing modes, but IPv6 is disabled by default.
- Wrong network settings may result in inaccessibility of your phone and may affect the network performance. Contact your system administrator for the network parameters.

## BASIC OPERATIONS

### TURNING CP930W ON/OFF

#### To turn the CP930W on, do one of the following:

- Long tap , wait, until the LCD screen lights up.
- Place the CP930W in the charging cradle. The CP930W will be turned on automatically.

#### To turn the CP930W off:

1. Long tap .
 

The LCD screen prompts you whether to power off the phone.
2. Tap the **Yes** soft key to continue.

## HANDSET SETTINGS

### HANDSET NAME





#### To rename the handset:

1. Tap **Menu->Settings->Basic Settings->Phone Name**.
2. Enter the value in the Phone Name field.
3. Tap the **Save** soft key to accept the change.

## VOLUME ADJUSTMENT

Tap  or  to adjust the volume of the speaker, ringer or media.

## RING TONES

1. Tap **Menu->Settings->Basic Settings->Sound->Ring Tones**.
2. Tap  or  to select **Common** or **Intercom Call**.
3. Tap  or  to select the desired ring tone.
4. Tap the **Save** soft key to accept the change.

## LOCAL DIRECTORY

### To add a contact:

1. Tap the **Directory** soft key from the idle screen.
2. Tap the **Add** soft key to add a contact.
3. Enter a unique contact name in the **Name** field and contact numbers in the corresponding fields.
5. Tap the **Save** soft key to accept the change.

### To edit a contact:

1. Tap the **Directory** soft key from the idle screen.
2. Select the desired contact, tap the **Options** soft key and then select **Detail**.
3. Edit the contact information.
4. Tap the **Save** soft key to accept the change.

### To delete a contact:

1. Tap the **Directory** soft key from the idle screen.
2. Select the desired contact, tap the **Options** soft key and then select **Delete**.



The LCD screen prompts you whether to delete the selected item.

3. Tap **Yes** to continue.



## BASIC CALL FEATURES

### PLACING CALLS

#### To place a call directly:



1. Do one of the following:
  - Tap , enter the phone number.
  - Enter the phone number.
2. Tap ,  or the **OK** key to dial out.

#### To place a call from the local directory:





1. Tap the **Directory** soft key from the idle screen.
2. Tap  or  to select the desired directory type.
3. Highlight the desired entry, and then tap  or the **OK** key to dial out.



**To place a call from the call history:**

1. Tap the **History** soft key when the IP phone is idle, and then select the desired call history list.
2. Tap  or  to highlight the desired entry, and then tap  or the **OK** key to dial out.

**To place a call from the redial list:**

1. Tap  when the IP phone is idle.
2. Tap  or  to highlight the desired entry, and then tap  or the **OK** key to dial out.

**ANSWERING CALLS****To answer a call, do one of the following:**

- Tap the **Answer** soft key.
- Tap .
- Tap the **OK** key.

**Note:**

- You can ignore an incoming call by tapping the **Silence** soft key or reject an incoming call by tapping .

**ENDING CALLS**

Tap  or the **End Call** soft key.

**CALL MUTE AND UNMUTE****To mute a call**

Tap  the mute key LED illuminates solid red.

**To unmute a call**

Tap  again to unmute the call. The mute key LED illuminates solid green.

**CALL HOLD AND RESUME****To hold a call:**

Tap the **Hold** soft key during a call.

**To resume a call:**

Tap the **Resume** soft key during a call.

**LOCAL CONFERENCE**

You can host a five-way conference with up to other four parties.

**To create a five-way local conference:**



1. Tap the **Conf.** soft key during an active call. The call is placed on hold.
2. Enter the number of the second party, and then tap the **Send** soft key.

You can also select a contact from **Directory** to join into a conference.

3. Tap the **Conf.** soft key again when the second party answers.
4. Repeat steps 2 to 3 to join more parties in the conference.

If you connect a mobile phone and PC to your phone, you can also create a seven-way hybrid UC conference.

**To manage the individual participant:**

1. Tap the **Manage** soft key during the conference.
2. Tap  or  to select desired participant, do the following:
  - Tap the **Far Mute** soft key to mute the participant. The muted participant can hear every one, but no one can hear the muted participant.
  - Tap the **Remove** soft key to remove the participant from the conference.
  - Tap the **Split All** soft key to split the conference call into individual calls on hold.

**CALL RECORDING**

You can insert an SD card into the SD slot on your phone to record active calls.

**To record audio calls:**

1. Tap the **More** soft key, and then tap the **StartREC** soft key during a call.
  2. Tap the **PauseREC** soft key to pause recording, tap the **Re REC** soft key to resume recording.
  3. Tap the **StopREC** soft key to stop recording. The record file will be saved.
- If you end a call during recording, the record file will be saved automatically.

**CALL TRANSFER**

You can transfer a call in one of the following ways:



**Blind Transfer**

1. Tap the **Transfer** soft key during a call. The call is placed on hold.
2. Enter the number you want to transfer the call to.



You can also select a contact you want to transfer to from **Directory**.

3. Tap the **Transfer** soft key.

**Semi-Attended Transfer**

1. Tap the **Transfer** soft key during a call. The call is placed on hold.
2. Enter the number you want to transfer the call to.
3. Tap ,  or the **OK** key to dial out.
4. Tap the **Transfer** soft key when you hear the ring-back tone.

**Attended Transfer**

1. Tap the **Transfer** soft key during a call. The call is placed on hold.
2. Enter the number you want to transfer the call to.
3. Tap ,  or the **OK** key to dial out.
4. Tap the **Transfer** soft key when the second party answers.

## CALL FORWARD

You can forward an incoming call to a contact, or forward all incoming calls to a contact.

### To forward an incoming call to a contact:

1. Tap the **Forward** soft key from the Incoming Call screen.
2. Enter the number you want to forward to.

You can also select a contact from **Directory**. The call is forwarded to the contact directly.

3. Tap the **Send** soft key.

### To forward all incoming calls to a contact:

1. Tap the **Menu** soft key.
2. Select **Features->Call Forward**.
3. Select the desired forwarding type:
  - **Always Forward**----Incoming calls are forwarded unconditionally.
  - **Busy Forward**----Incoming calls are forwarded when the phone is busy.
  - **No Answer Forward**----Incoming calls are forwarded if not answered after a period of time.
4. Select **Enabled** from the **Status** field.
5. Enter the number you want to forward to in the **Target field**.
6. For **No Answer Forward**, select a desired ring time to wait before forwarding from the **After Ring Time** field.
7. Tap the **Save** soft key to accept the change.

## Regulatory Notices

### Operating Ambient Temperatures

- Operating temperature: +32 to 104°F (0 to 40°C)
- Relative humidity: 5% to 90%, noncondensing
- Storage temperature: -22 to +160°F (-30 to +70°C)

### Warranty

Our product warranty is limited only to the unit itself, when used normally in accordance with the operating instructions and the system environment. We are not liable for damage or loss resulting from the use of this product, or for any claim from a third party. We are not liable for problems with Yealink device arising from the use of this product; we are not liable for financial damages, lost profits, claims from third parties, etc., arising from the use of this product.

### Explanation of the symbols

- DC symbol

— is the DC voltage symbol.

- WEEE Warning symbol

 To avoid the potential effects on the environment and human health as a result of the presence of hazardous substances in electrical and electronic equipment, end users of electrical and electronic equipment should understand the meaning of the crossed-out wheeled bin symbol. Do not dispose of WEEE as unsorted municipal waste and have to collect such WEEE separately.

### Restriction of Hazardous Substances Directive (RoHS)

All adapter devices comply with the requirements of the EU RoHS Directive. Statements of compliance can be obtained by contacting support@yealink.com.

### Safety Instructions

Save these instructions. Read these safety instructions before use!

#### General Requirements

- Before you install and use the device, read the safety instructions carefully and observe the situation during operation.
- During the process of storage, transportation, and operation, please always keep the device dry and clean, avoid collision and crash.
- Please attempt not to dismantle the device by yourself. In case of any discrepancy, please contact the appointed maintenance center for repair.
- Please refer to the relevant laws and statutes while using the device. Legal rights of others should be respected as well.

#### Environmental Requirements

- Place the device at a well-ventilated place. Do not expose the device under direct sunlight.
- Keep the device dry and free of dusts.
- Do not place the device on or near any inflammable or fire-vulnerable object, such as rubber-made materials.
- Keep the device away from any heat source or bare fire, such as a candle or an electric heater.

#### Operating Requirements

- Do not let a child operate the device without guidance.
- Do not let a child play with the device or any accessory in case of accidental swallowing.
- Please use the accessories provided or authorized by the manufacturer only.
- The power supply of the device shall meet the requirements of the input voltage of the device. Please use the provided surge protection power socket only.
- Before plugging or unplugging any cable, make sure that your hands are completely dry.
- Do not spill liquid of any kind on the product or use the equipment near water, for example, near a bathtub, washbowl, kitchen sink, wet basement or near a swimming pool.
- During a thunderstorm, stop using the device and disconnect it from the power supply. Unplug the power plug and the Asymmetric Digital Subscriber Line (ADSL) twisted pair (the radio frequency cable) to avoid lightning strike.
- If the device is left unused for a rather long time, disconnect it from the power supply and unplug the power plug.
- When there is smoke emitted from the device, or some abnormal noise or smell, disconnect the device from the power supply, and unplug the power plug immediately.
- Contact the specified maintenance center for repair.
- Do not insert any object into equipment slots that is not part of the product or auxiliary product.
- Before connecting a cable, connect the grounding cable of the device first.

Do not disconnect the grounding cable until you disconnect all other cables.

#### Battery Requirements

- Do not immerse the battery into water, which could short-circuit and damage the battery.
  - Do not expose the battery to an open flame or leave the battery where it could be subjected to extremely high temperatures, which could cause the battery to explode.
  - Do power the handset off before removing the battery.
  - Do not try to use the battery for the power supply of any device other than this handset.
  - Do not open or mutilate the battery, released electrolyte is corrosive and may cause damage to the your eyes or skin.
  - Use only the rechargeable battery pack delivered with the handset or those rechargeable battery packs expressly recommended by Yealink.
- Defective or exhausted battery should never be disposed of as municipal waste. Return old battery to the battery supplier, a licensed battery dealer or a designated collection facility.

#### Cleaning Requirements

- Before cleaning the device, disconnect it from the power supply.
- Use a piece of soft, dry and anti-static cloth to clean the device.
- Keep the power plug clean and dry.

### Troubleshooting

The unit cannot supply power to device other than Yealink device.

There is a bad connection with the plug.

1. Clean the plug with a dry cloth.
2. Connect it to another wall outlet.

The usage environment is out of operating temperature range.

1. Use in the operating temperature range.

The cable between the unit and the Yealink device is connected incorrectly.

1. Connect the cable correctly.

You cannot connect the cable properly.

1. You may have connected a wrong Yealink device.

Some dust, etc., may be in the port.

1. Clean the port.

Contact your dealer or authorized service facility for any further questions.

### FCC Statement

This device complies with part 15 of the FCC Rules. Operation is subject to the following two conditions: (1) this device may not cause harmful interference, and (2) this device must accept any interference received, including interference that may cause undesired operation.

Any Changes or modifications not expressly approved by the party responsible for compliance could void the user's authority to operate the equipment.

### IC Statement

This device complies with Industry Canada's licence-exempt RSSs. Operation is subject to the following two conditions:

- (1) this device may not cause interference; and
- (2) this device must accept any interference, including interference that may cause undesired operation of the device. CAN ICES-3(B)

Le présent appareil est conforme aux CNR d'Industrie Canada applicables aux appareils radio exempts de licence. L'exploitation est autorisée aux deux conditions suivantes :

- (1) l'appareil ne doit pas produire de brouillage;
- (2) l'utilisateur de l'appareil doit accepter tout brouillage radioélectrique subi, même si le brouillage est susceptible d'en compromettre le fonctionnement. NMB-3(B)

### Radiation Exposure Statement

This equipment complies with FCC and IC radiation exposure limits set forth for an uncontrolled environment. This equipment should be installed and operated with minimum distance 20cm between the radiator and your body.

Cet émetteur ne doit pas être Co-placé ou ne fonctionnant en même temps qu'aucune autre antenne ou émetteur. Cet équipement devrait être installé et actionné avec une distance minimum de 20 centimètres entre le radiateur et votre corps.

### Contact Information

YEALINK NETWORK TECHNOLOGY CO.,LTD.

309, 3rd Floor, No.16, Yun Ding North Road, Huli District, Xiamen City, Fujian, P.R. China

YEALINK (EUROPE) NETWORK TECHNOLOGY B.V.

Strawinskylaan 3127, Atrium Building, 8th floor, 1077ZX Amsterdam, The Netherlands

YEALINK (USA) NETWORK TECHNOLOGY CO., LTD.

999 Peachtree Street Suite 2300, Fulton, Atlanta, GA, 30309, USA

Made in China

### About Yealink

Yealink is a global leading provider of enterprise communication and collaboration solutions, offering video conferencing service to worldwide enterprises. Focusing on research and development, Yealink also insists on innovation and creation. With the outstanding technical patents of cloud computing , audio, video and image processing technology, Yealink has built up a panoramic collaboration solution of audio and video conferencing by merging its cloud services with a series of endpoints products. As one of the best providers in more than 140 countries and regions including the US, the UK and Australia, Yealink ranks No.1 in the global market share of SIP phones shipments.

### Technical Support

Visit Yealink WIKI (<http://support.yealink.com/>) for the latest firmware, guides, FAQ, Product documents, and more. For better service, we sincerely recommend you to use Yealink Ticketing system (<https://ticket.yealink.com>) to submit all your technical issues.



CP930W-Base & CP930W-EN

YEALINK(XIAMEN) NETWORK TECHNOLOGY CO.,LTD.  
 Web: [www.yealink.com](http://www.yealink.com)  
 Addr: 309, 3rd Floor, No.16, Yun Ding North Road, Huli  
 District, Xiamen City, Fujian, P.R. China  
 Copyright©2018 YEALINK(XIAMEN) NETWORK  
 TECHNOLOGY CO.,LTD.All rights reserved.